

**Viktor Obendrauf**

University of Graz, Institute of Chemistry  
A-8010 Graz, Schubertstraße 1  
e-mail: viktor@obendrauf.com

**MORE SMALL SCALE HANDS ON EXPERIMENTS FOR EASIER TEACHING AND LEARNING**

„A *pretty* experiment is in itself often more valuable than twenty formulae extracted from our minds. *Albert Einstein (1879-1955)*“

Neurobiological research proves that lasting learning is closely linked to emotions. A ‚pretty‘ reaction arouses emotions just like a dangerous or a dangerous looking experiment.

Many colleagues can confirm that most of the students remember nothing better than ‚beautiful‘ or ‚dangerous‘ experiments. Through aesthetically arranged and really exciting experiments they frequently grasp the associated theoretical concepts more easily.

Of course, definitely dangerous experiments must be cancelled in school. Chemical education should be as safe as possible for teachers and students. But chemical demonstrations which are classified as possibly dangerous by the students can support learning with emotions. Using microscale techniques many potentially dangerous reactions can be performed in a safe and inexpensive way.

There exists no scientific definition for aesthetic science phenomena. But there exists a general consensus that chemical demonstrations and students activities can be designed more or less pretty. Classical examples of aesthetic reactions and/or aesthetically presented processes are various coloured structures and crystallisations in Petri dishes, projection cuvettes and on microscope slides. For many people pyrotechnic effects are beautiful. Even the burning down of a simple ice candle can create emotions. Many burning ice candles arranged as pyrotechnic numbers and letters are much more than a simple reaction between heated titanium particles with oxygen of the air.

For many students, unclear experimental arrangements are not elegant or even beautiful. They want to pick up the experiment and the concepts behind it as fast as possible. A simple and clear experimental procedure without many fixing stands and clamps, that is focused on a microscale level and enlarged with modern electronic equipment for large auditoriums, can sometimes improve both the aesthetics and safety of potentially dangerous experiments.

For many teachers and lecturers, experimental procedures are not elegant and pretty when they require expensive and time-consuming preparations and exhausting clean ups with lots of waste. Going microscale can improve the aesthetics and the safety of chemical reactions by reducing the time, costs and waste.

Six years ago it was a big honour and also a great pleasure for me to be invited to give a plenary lecture during the 16<sup>th</sup> ICCE in Budapest dealing with small scale and microscale gas reactions. The audience agreed that special video techniques can be very useful for performing time-saving and cost-saving small scale reactions in big lecture-theatres without polluting the environment. By enlarging the improvised low-cost-equipment with modern digital video projection techniques the properties of very poisonous gases can be safely demonstrated without a fumehood. The experimental topics during the lecture in Budapest were: the generation of chlorine, acetylene, hydrogen, hydrogen sulphide, sulphur dioxide, ammonia and oxygen, the reactions between sodium and chlorine, hydrogen and chlorine, chlorine and acetylene, hydrogen and oxygen, hydrogen sulphide and sulphur dioxide.

The same low cost equipment and digital video techniques — enriched with some special products from any European supermarket and a couple of improved ideas to generate, store and dispose small amounts of hazardous gases — should be used for the lecture in Seoul.

In any case, the discussed small scale experiments are not designed for combination with video techniques. For normal classrooms, the philosophy is that a badly arranged experiment in a fumehood or behind a safety shield is less impressive for creating emotions than a small scale portable apparatus which needs no fixing stands and allows the lecturer to perform and repeat the experiments closer to the students.

Detailed instructions and figures dealing with the special materials necessary for these low cost gas generations and small scale gas reactions are described in the book of abstracts of the 16<sup>th</sup> ICCE 2000 in Hungary. These materials have successfully been used for more than ten years in Europe and should be described again for those colleagues and teachers in Asia who have had no chance to pick up these experimental suggestions until now.

### Material © for the low cost gas generation and gas reactions [1,2,3]:

- (a) 1 test-tube Schott Fiolax® 16/160 mm, bulged mouth.

In this test tube the gases are generated. The rather thin but fireproof material heats up the substances inside in a very short time; if it is necessary, this substance can be cooled down again in a water bath or with tap water in a few seconds.

- (b) 1 soft rubber-stopper (Verneret18D) with 1 or 2 syringe needles (1.2/40 mm) pierced through the stopper as shown in figure 1.

The tips of the needles in the stopper must be cut off as shown in picture 2. The blunt needles in the stopper work as micro steel tubes with luer connections. Needles without tips are no longer needles. Even with differently strong acids, the stopper works for many months without having to replace the tubes.

- (c) 1 disposable syringe 2 ml (e.g. Braun ®)

This syringe is used as a dropping funnel for liquids. The plunger (without washer) must be difficult to move. For this property a rough surface inside the syringe prepared with fine iron wool is very useful.

To suck up the needed liquid it is useful to have the chemicals in 10-20 ml narrow mouthed bottles. As a result, even concentrated hydrochloric acid or concentrated ammonia solution is no problem outside the fume hood. To avoid contact with the adhered chemicals after filling, the syringe must be cleaned outside with a paper towel or rinsed in a beaker with water or with tap water. Then the syringe can be placed tightly in the luer connection steel tube of the special stopper.

- (d) 1 syringe 20 ml, eccentric luer conus (ONCE ®) This syringe is used to collect and store the generated gas and stoichiometric mixtures. To avoid pressures that are too high in the apparatus, the plunger must be easily movable when compared to the 2ml-syringe. Therefore the washer at the end of the plunger must be slightly greased with high boiling silicon oil.

- (e) 1 10 ml syringe without a plunger, first filled with activated charcoal granular and then closed with 1 rubber stopper with 1 syringe needle in it as shown in figure 1

This device is very useful to avoid excessively hazardous gases coming out of the gas generator when the 20 ml syringe is filled and no more gas is needed.

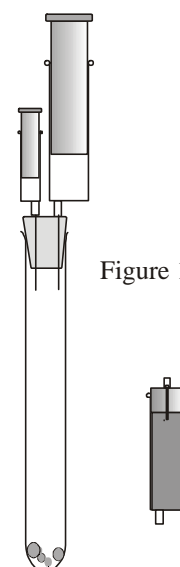

Figure 1

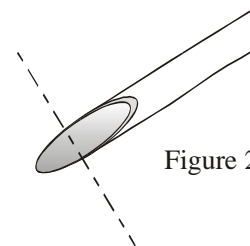
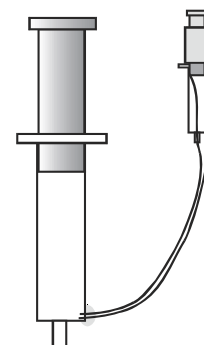

Figure 2

- (f) 20 ml disposable syringe (ONCE®) with inserted piezoelectric sparker (figure 3)

This device, built from a 20 ml disposable syringe and a piezoelectric lighter allows one to collect various explosive mixtures of gases to show the stoichiometric reactions in the syringe directly. Constructing the device: A nail is heated in a flame, this hot nail is used to melt a small hole in the syringe, a stereo wire with blank metal ends is inserted through the hole and the connection is sealed with hot-glue as shown in figure 3. The other end of the wire must be connected to the piezoelectric sparker so that it works (see figure 3).

Figure 3



- (g) Steel tubes 1.2/40 mm with luer connections (syringe needles with cut tips). The thin steel tubes with the luer connections and the blunt end serve for jets, e.g. either a) to light hydrogen or acetylene pressed out from a syringe or b) to jet the wanted gas into a test-tube or into another syringe. The steel tubes placed the soft rupper stoppers or serving for jets work for many months without destroying in corrosion even in contact with concentrated acids. To avoid corrosion during storage, the steel tubes must be rinsed inside with water and dried with air. This procedure consumes only a couple of seconds: Using a 20 ml syringe press some water through the tubes and dry the tubes inside by sucking and pressing air through them.
- (h) Steel tubes 0.8/120 mm with luer connections (syringe needles with cut tips)

The long syringe needles can be used as a reaction tube with a very big (catalyzed or not catalyzed) surface inside e.g. to heat a stoichiometric mixture of sulphur dioxide and

oxygen or as catalyst tube for the catalytic reaction between ammonia and oxygen (Ostwald procedure see figure 4) etc.

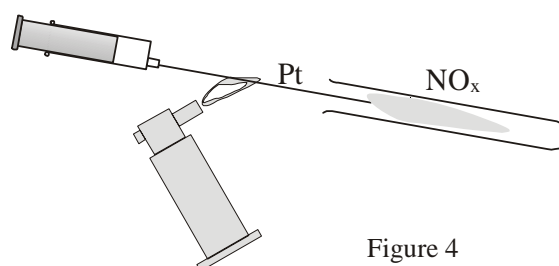
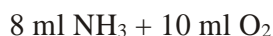

Figure 4

The modified and strongly heated long needle can also be used to decompose gaseous compounds e.g. ammonia or for thermolysis reactions (e.g. paraffin oil to gaseous hydrocarbons).

- (i) Micro burner  
Portable, with piezoelectric sparker, refillable with lighter butane, burner time not limited, size of the flame adjustable, works in each position (see figure 4)
- (j) 15-20 cm long pieces of insulator from a stereo wire (copper wire removed), used as thin plastic tubes
- (k) 100 ml disposable syringe with catheter connection (Figure 5)

This syringe is used to collect, store and weigh larger amounts of gases. The catheter connection fits to the luer connection of smaller syringes and to the outlet of a special wine bottle opener which works very comfortably with commercial chargers filled with carbon dioxide for soda bottles or nitrous oxide for whipped cream.

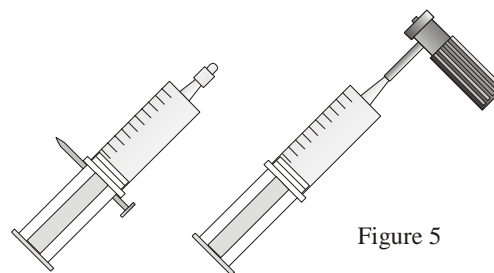

Figure 5

## (l) Mobile small scale ozone generator

Using a silicon tube a normal small scale oxygen gas generator is connected to a test tube which contains a thin glass tube filled with a salt solution (e.g. copper sulphate). This solution is in contact with a small high voltage device (stun gun, see figure 6). The second connection of the high voltage device leads to a sheet of copper or brass outside the test tube, so that discharges can be produced from outside the test tube to the thin glass tube inside the test tube. Pure oxygen inside the test tube can be converted to ozone partially. Ozone mixed with normal oxygen can be collected in a 20ml syringe (see fig 6)

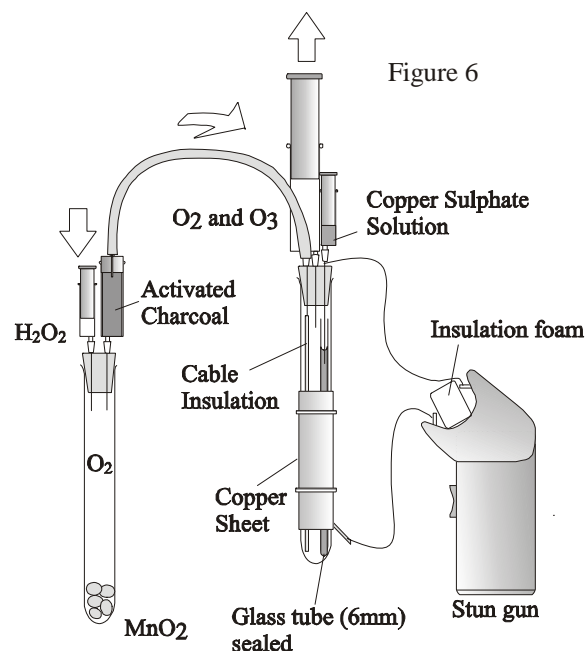

Figure 6

## (m) Explosion Limits Film Can

A Fuji® film can (with a snap cap) equipped with a piezoelectric device can be used to check the explosion limits of very low boiling organic liquids such as acetone or ethyl acetate. The volume of the film can is about 33 cm<sup>3</sup>.

A very small but accurate amount of completely evaporated acetone or ethyl acetate should give a mixture within the explosion limits.

Example: Explosion limits of acetone (LEL: with 60 g acetone/m<sup>3</sup> air = about 2 mg acetone/33 cm<sup>3</sup>. UEL: 310 g acetone/m<sup>3</sup> air = 10 mg acetone/33 cm<sup>3</sup>).

1 very small drop of acetone is about 7-9 mg which means that 1 drop of acetone completely evaporated and mixed with the air inside the closed film can is within the explosion limit. 2 drops or more give a mixture which is too rich.

Special lighter fuel (not lighter gas) such as ZIPPO® lighter fuel consists of octane and familiar hydrocarbons with a proper vapour pressure of about 0,0147 bar so that excess liquid in the closed film cannot produce too rich mixtures. Example: The calculated amount of oxygen in the film can is about 6,9 cm<sup>3</sup>. The volume x of the vapour in the closed film can with excess liquid in it should not be more than about 0,5 cm<sup>3</sup>. (x cm<sup>3</sup> : 0,0147 bar = 33cm<sup>3</sup> : 1,0147 bar) Compared to 6,9 cm<sup>3</sup> is the mixture is the hydrocarbon vapour near the stoichiometric mixture: HC : O<sub>2</sub> = 0,5 : 6,9 = about 1:14. (C<sub>8</sub>H<sub>18</sub> + 12,5 O<sub>2</sub> → 8 CO<sub>2</sub> + 9 H<sub>2</sub>O). It is possible to produce many harmless explosions in the can after replacing the air and closing the container.

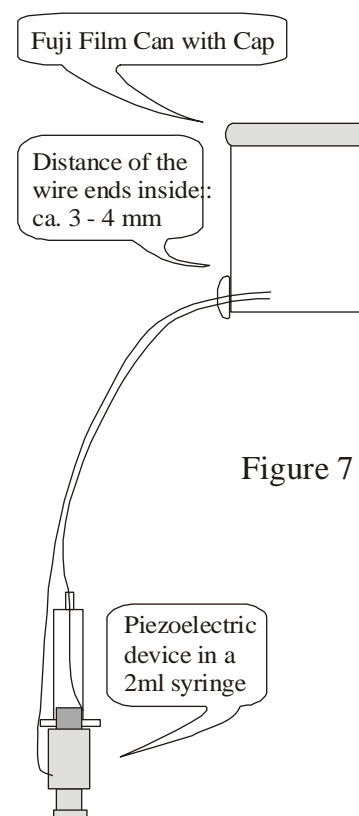
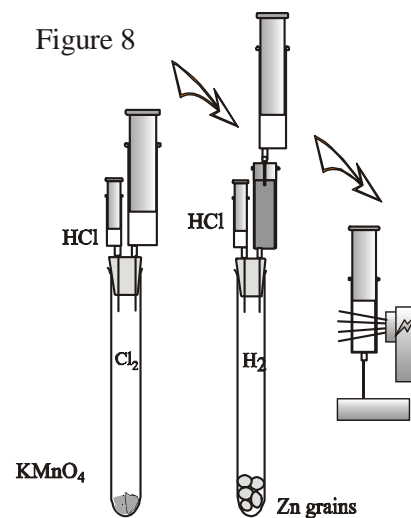

Figure 7

MORE EXAMPLES OF EXPERIMENTS WHICH ARE WELL KNOWN BUT ARE NEWLY DESIGNED, SMALL SCALE AND DONE WITHIN 3-5 MINUTES:

### 1. Photolytic reaction between hydrogen and chlorine

The air in the chlorine gas generator is replaced by generating chlorine, the air in the hydrogen gas generator is replaced by generating hydrogen. To make sure that the flash will work with the mixture every time, the hydrogen can be cleared of hydrochloric gas. Connect the 10 ml syringe filled with charcoal with the hydrogen gas generator and replace the air in the charcoal by hydrogen. Then connect the 20 ml syringe filled with 10 ml pure chlorine with the luer conus connection of the charcoal filled syringe. Add 10 ml purified hydrogen (figure 8). The syringe with the collected gas mixture is placed vertically using a cut needle on a foam base as a stand. If the sheet of the flash covers the attached 20ml syringe completely, the reaction will start every time without removing the UV filter from the flash (see figure 8).



### 2. Generation of NO<sub>x</sub> using copper and nitric acid, properties of NO, NO<sub>2</sub>, N<sub>2</sub>O<sub>3</sub>, N<sub>2</sub>O<sub>4</sub>

After replacing the air in the gas generator the well-greased special 20 ml syringe is used to collect the generated NO<sub>x</sub>. A 10 ml syringe without a plunger, first filled with activated charcoal granular and then closed with a rubber stopper, pierced by one syringe needle, functions as a portable fumehood, after the the 20 ml syringe has filled up with the poisonous mixture. With the generated mixture in the 20 ml syringe the solubility of NO<sub>2</sub> in water, the equilibrium between NO<sub>2</sub> and N<sub>2</sub>O<sub>4</sub>, the formation of N<sub>2</sub>O<sub>3</sub> and a couple of other properties of the gas mixture can be shown easily.

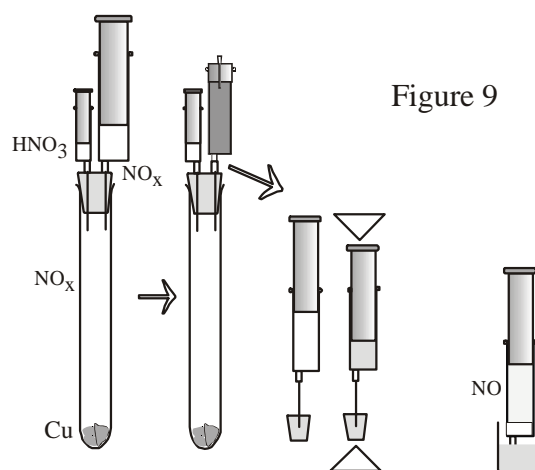

Using a gas generator for carbon monoxide the catalytic reaction between CO and NO to N<sub>2</sub> and CO<sub>2</sub> can be formed in a test tube which contains pieces of a normal car catalyst.

### 3. Instant chemistry: Micro-ampoules as pressure-resistant permanent preparations [4]

Thick sided glass ampoules often serve as containers for liquified gases and highly evaporable liquids. These chemical-physical „permanent preparations“ have the advantage that they demonstrate various phenomena without spending too much time on preparation and cleaning up. If you reduce the volume of the ampoules to a few micro-litres, the ampoules containing various substances can be sealed, given some care and experience, without the help of a professional glassblower. Modern soldering torches with accurate flames make the preparation of such micro-ampoules (2-3 mm in diameter!) a lot easier.

In spite of their thin glass the tiny tubes resist enormous pressure so that you can even seal liquified carbon dioxide or laughing gas. This makes it possible to demonstrate the phenomenon of critical temperatures of various substances in a surprisingly easy way. For example, the critical temperature of liquified nitrous oxide, which is 36.5°C, can be reached

with the help of a hairdryer within seconds, so that the liquid inside the ampoule suddenly disappears. After all, the corresponding critical pressure amounts to 72.6 bar. Similar experiments can be carried out with liquified carbon dioxide (critical temperature 31.6°C, critical pressure 73.8 bar). A slight cooling ends this simultaneity of liquid and vapor and the liquid state is seemingly re-formed from nothing. Liquid, gaseous and – if liquid nitrogen is available – even solid chlorine can thus be produced just as quickly as the temperature dependent equilibrium between  $\text{NO}_2$  and  $\text{N}_2\text{O}_4$ . If the mixture contains  $\text{NO}$  and  $\text{NO}_2$ , the deep blue  $\text{N}_2\text{O}_3$  can be permanently preserved in quite a spectacular way even at room temperature (traditionally this is only possible through cooling). Above its melting point (-100.1°C)  $\text{N}_2\text{O}_3$  decomposes according to the following equilibria:

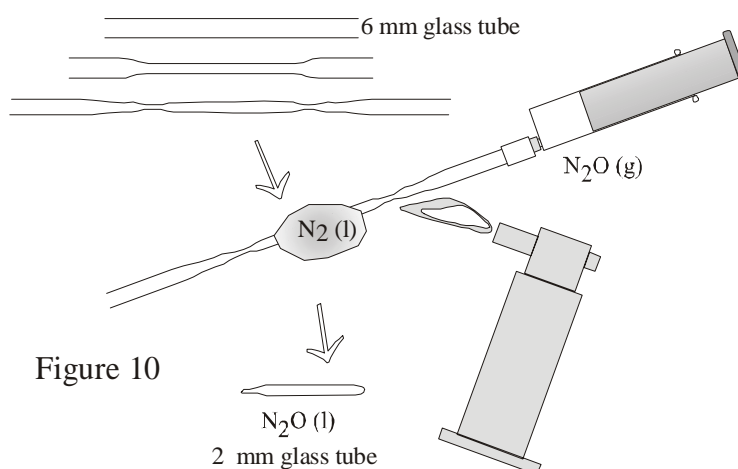
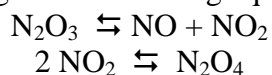
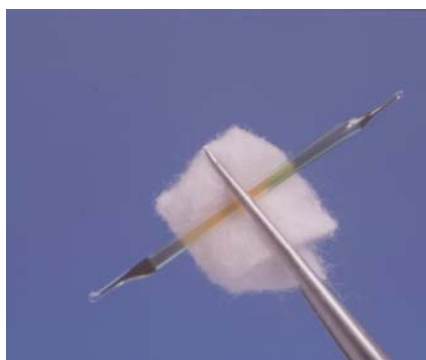

Figure 10



If you do not keep on cooling the ampoule after sealing it, the light blue solid substance will melt, first into a deep blue liquid state which, because of the extremely high pressure, does not even disappear at room temperature (according to the principle of Le Chatelier). Heating up the micro-ampoule with a hairdryer enables you to demonstrate the concentration of the brown gaseous state caused by the intensified production of  $\text{NO}_2$  from  $\text{N}_2\text{O}_4$  within seconds.



In addition to the described phenomena, micro-ampoules enable you to demonstrate lots of other temperature dependent chemical-physical processes („Instant Chemistry“!) [4]. Even in very large lecture halls, they can easily be visualized by means of modern video cameras

#### 4. A wine bottle opener as a source for $\text{N}_2\text{O}$ – the „barking dog“ without $\text{NO}$ and $\text{CS}_2$ [6]

$\text{N}_2\text{O}$  (laughing gas) in high pressure steel ampoules is used to produce whipped cream. Special wine bottle openers work with the same type of steel ampoules containing carbon dioxide. Therefore those wine bottle openers can also serve as source for  $\text{N}_2\text{O}$  so that many experiments involving  $\text{N}_2\text{O}$  can be designed as „Instant Chemistry“ examples [5,6,7,8,9]

E.g.: Using the wine bottle opener it is possible to fill a wide mouthed 1 litre glass bottle with laughing gas within one minute. Instead of poisonous  $\text{CS}_2$  normal rum (80% ethanol) is evaporated at hot tap water temperatures so that the noise and the blue flash of the famous „barking dog“ can be performed with material bought exclusively from the super-market. The nice reaction may follow this reaction path:





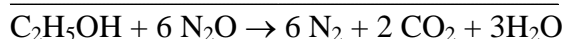
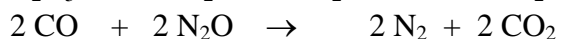
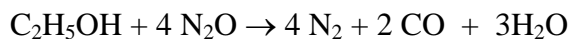

### 5. Microscale dry ice production and microscale liquefied laughing gas [10].

Two exciting and pretty examples of gases are well known in the kitchen: carbon dioxide and laughing gas. Both laughing gas and carbon dioxide are simple substances in every day life. Both laughing gas and carbon dioxide are stored in very similar looking steel cartridges for whipped cream chargers and for soda siphon chargers. Both gases can be used in sufficient amounts for chemical education in a special wine bottle opener. [3,4,5]

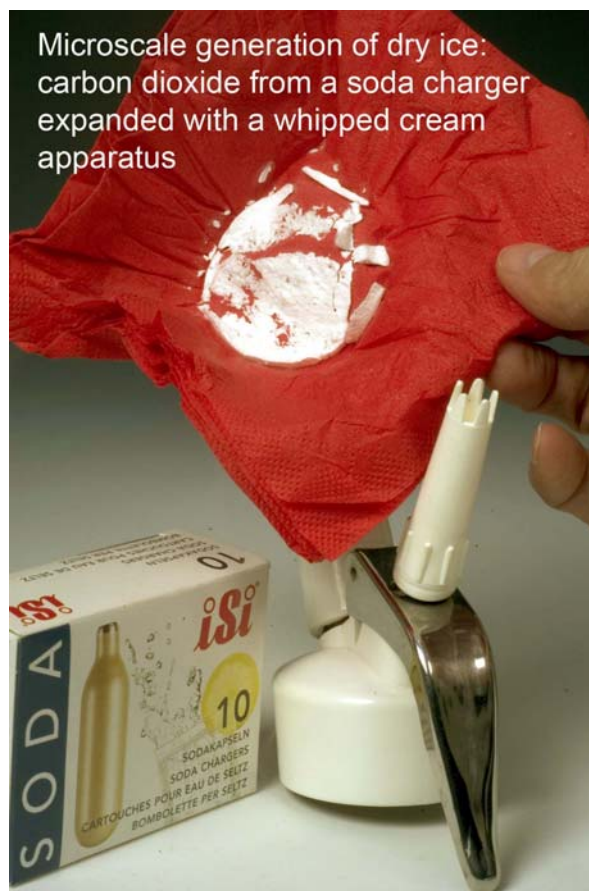

Compared to carbon dioxide nitrous oxide is a gas with very similar physical properties (see table 1). Many similar physical material data e.g. density, molar mass, solubility in water and critical temperature can be demonstrated in a very simple way. Experimental stuff from schools combined with special supermarket products is sufficient.

Table 1

	N <sub>2</sub> O	CO <sub>2</sub>
Structure	N=N=O	O=C=O
Molecular mass	44,01 u	44,01 u
Litre mass	1,997g/l	1,977g/l
Melting point	-90,8°C	-57°C (5,2 bar)
Boiling point	-88,8°C	-78,5° (sublimation)
Critical temperature	36,5°C	31,06°C
Critical pressure	72,6 bar	73,83 bar
Critical density	0,457g/l	0,464 g/l

The chemical properties and the physiological effects of nitrous oxide and carbon dioxide with iso-electronic structures of its molecules are completely different.

Laughing gas is not only used to make whipped cream. Many students know that nitrous oxide could be used for sniffing. Of course it is used in hospitals for anaesthesia, it is further more well known as an very effective oxidizer in combustion engines. Using small amounts of laughing gas the properties as an oxidizing agent can be demonstrated in various simple and timesaving ways [4-7].

On the other hand a soda siphon cartridge contains carbon dioxide which can be used as a fire extinguishing gas. A special recipe to produce small amounts dry ice from one single soda siphon charger gives us the chance to show the sublimation and the triple point in a small syringe even for a big audience [6-10].

### 6. The basis of a safety match [11]

Safety matches use a match head that is mainly  $\text{KClO}_3$ , struck against the match box surface, which consists of non-toxic red phosphorus (about 50%). Placed outside the matchbox, instead of in the match-head, the match can only be ignited through friction with the red phosphorus panel. This is the basis for the safety match, which can be shown without any laboratory equipment if only microscale amounts of the potentially dangerous chemicals are involved. The reaction on a microscale level, stoichiometry, calculation, and safety goggles

Microscale amounts of hazardous chemicals can be safe even between two fingers:



...the chemical reaction that takes place when one strikes a match



prevent possible accidents. Concerning the equation with 0,00010 mol (about 12,3 mg finely powdered)  $\text{KClO}_3$  and 0,00012 mol (about 3,7 mg dried phosphorous) a nice flash can be produced in theory. To be sure that the red phosphorous will react completely with the solid oxidizing agent and cannot burn on the skin with the oxygen of the air, excess  $\text{KClO}_3$  (about 40 mg) is necessary and essential!

### 7) Pictures can say more than words

The described material for the low cost gas generation for many microscale gas reactions can be stored in two or three plastic video cassette boxes. Using this equipment more than hundred different and context based reactions can be performed.

It should be noted that particular emphasis is laid on the described test-tubes, syringes and 'soft rubber' stoppers. The material used in these procedures is essential for being on the safe side with successful results. If somebody uses other test-tubes, disposable syringes and normal 'red' or black rubber bungs as available in most science education suppliers' catalogues the described technique for a mobile low cost gas generation without a fumehood will probably fail. The following pictures should show the wide range of possibilities.





The examples have been found to be particularly useful in demonstrating potentially **very** dangerous reactions relatively safely on a very small scale but still with a spectacular result. Chemical demonstrations and lab activities should be done as small as necessary, but not as small as possible.

### 7.1. Inverse flames

Is oxygen able to burn? This question could arise during the inverse flame experiment which

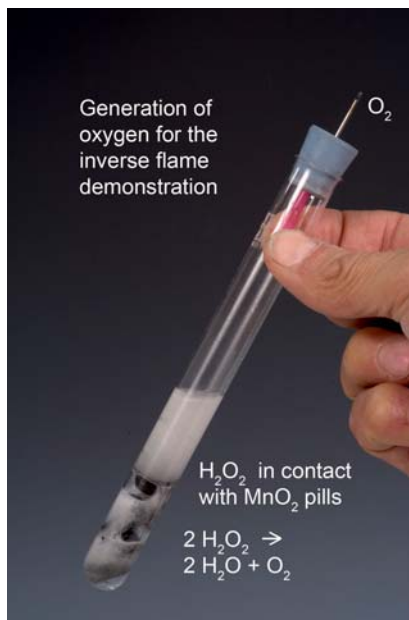

was very famous in the 19<sup>th</sup> century (see figure below). The potentially dangerous experiment is dealing with pure oxygen and pure hydrogen.

In a pure hydrogen atmosphere pure oxygen delivered from a small tube seems to burn with a nice flame, if the reaction between the elements can be started before a very dangerous mixture can be formed. The reaction on a normal scale would be dangerous. This may be one of the reasons why

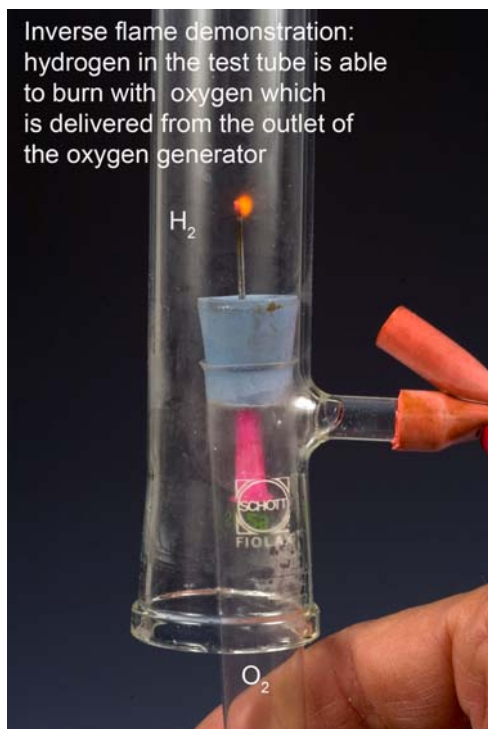

the inverse flame experiment disappeared out of the sourcebooks for chemistry teachers.

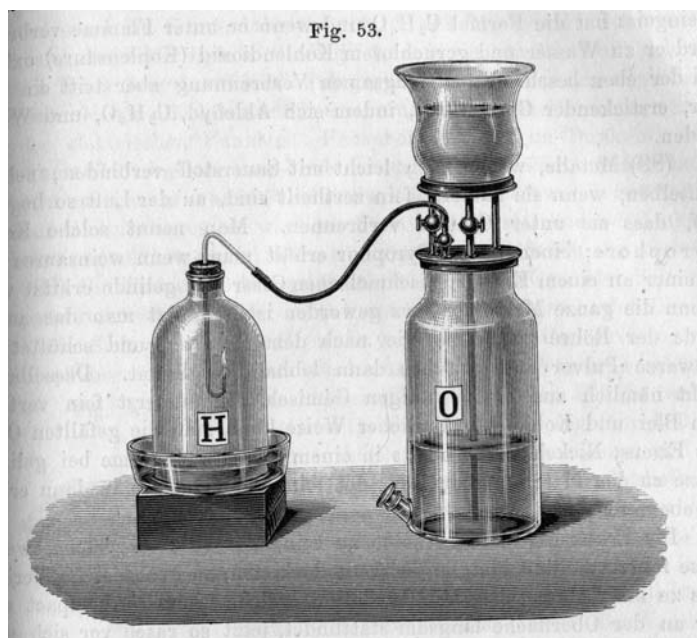

Using the described low cost material© with special test tubes, stoppers and syringes the inverse flame experiment can also be performed with pure chlorine delivered from a syringe with a small steel tube (needle with cut dip) on it. Chlorine seems to burn in pure hydrogen.

## 7.2. Chemical vapour deposition (CVD) modelling experiment [12]



Silane is generated by the reaction of magnesium silicide with 1 M HCl (aq) in the special small test tube. Before this reaction can be initiated the air in the gas generator can be replaced easily using a cooling spray (FHC). The generated silane can burn only at the end of the glass tube as shown in the picture above. Through heating the glass tube the delivered gas will be decomposed inside so that a thin film of silicon appears. The produced hydrogen can be collected and detected.



Using a microflame the thin film silicon can be heated for demonstrating the semiconducting properties of the layer (CVD). In addition the self ignition of silane is a nice experience.

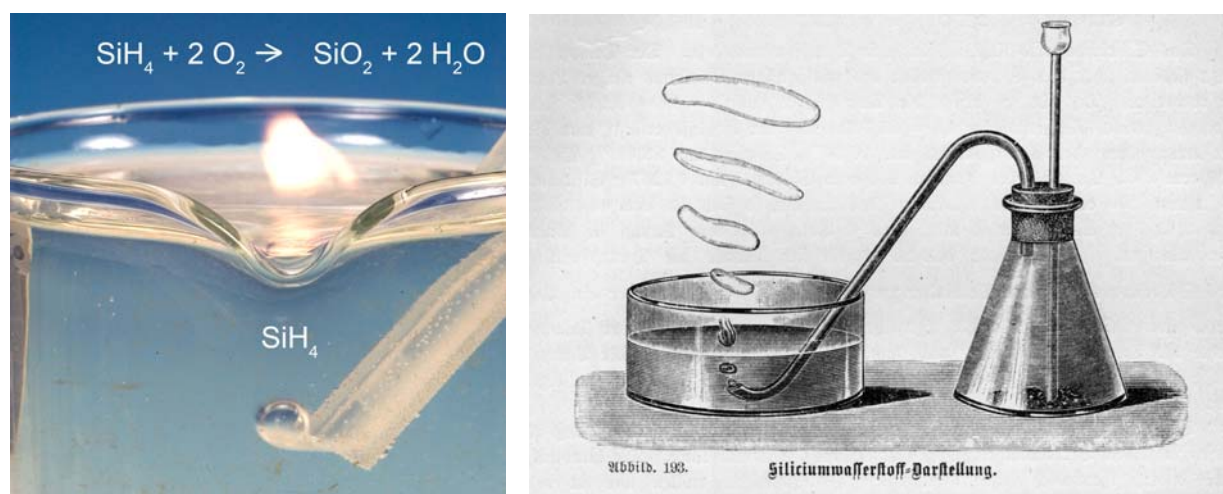

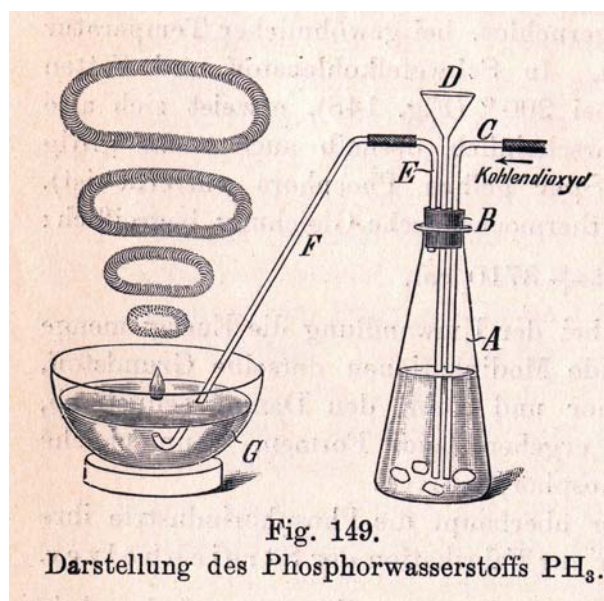
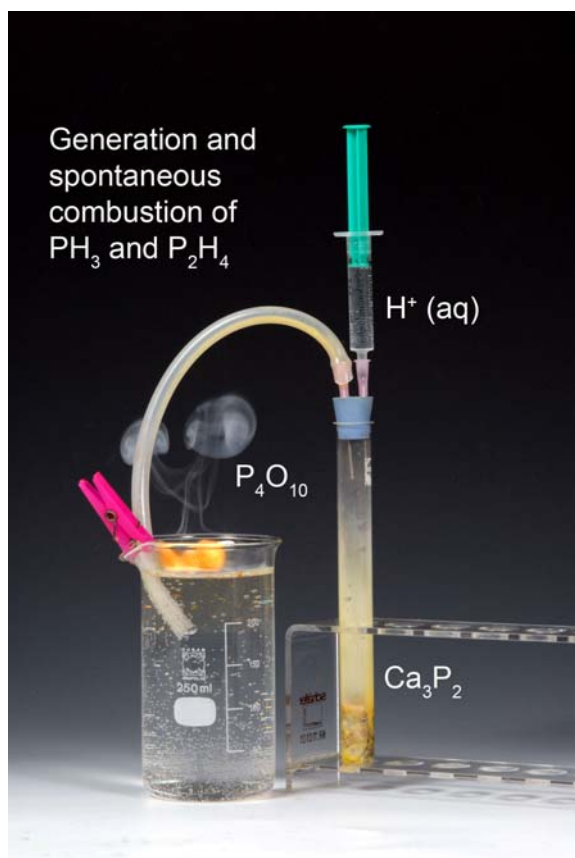

7.3. Self ignition of  $P_2H_4$  [13]

With a commercial rodenticide containing 28 % of  $Ca_3P_2$  the self ignition of very poisonous  $PH_3$  contaminated with  $P_2H_4$  can be shown similar to the self ignition of silane. Small amounts of chemicals in the small gas generator reduce the danger and the time for the preparations.

## 7.4. Chlorine and bromine without a fumehood, photolytic reaction with pentane [14]

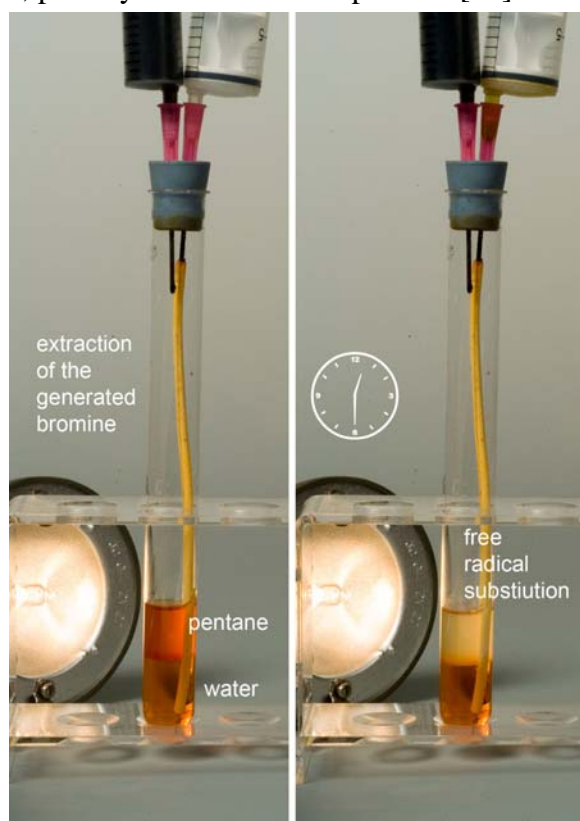
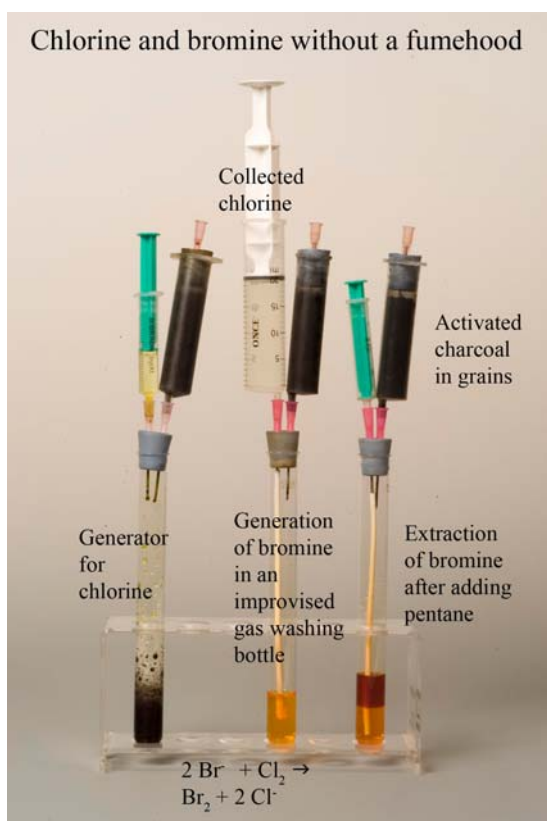

## 7. 5. Sparks from a piezoelectric device for at least 20 various explosive mixtures [3, 15]



Warning: The short description of the experiments shown in the pictures and figures above is only useful for this abstract. If somebody want to perform these potentially dangerous experiments, the original literature [1-15] with detailed descriptions and helpful references for a safe troubleshooting is strongly recommended.

## Literature:

- [1] V. Obendrauf, Low Cost Gas Generation for Small Scale Hands on Experiments, 16<sup>th</sup> ICCE, Budapest, **2000**, Book of abstracts
- [2] V. Obendrauf, Experimente mit Gasen im Minimaßstab. *ChiuZ* **1996**, 30 (3) 118
- [3] V. Obendrauf, Die Low-Cost-Lachgas-Kanone. *PdN-ChiS* 1999, 48 (3), 35
- [4] V. Obendrauf, Gläserne Hochdruckbehälter im Mikromaßstab, *PdN-Ch* **2000**, 49 (5) 4
- [5] V. Obendrauf, Lachgas auf Knopfdruck, *Chem.Sch.(Salzbg.)* **2001**, 16 (2) 4
- [6] V. Obendrauf, Der „Bellende Hund“ m. Mitteln des Alltags, *Chem.Sch.(Salzbg.)* **2001**, 16 (4) 11
- [7] V. Obendrauf, Sichtbarer Kohlenstoff aus unsichtbarem CO<sub>2</sub>, *Chem.Sch. (Salzbg.)* **2002**, 17 (1) 13
- [8] V. Obendrauf, Von der Sahnekapsel zur Modellrakete, *Chem.Sch. (Salzbg.)* **2003**, 18 (3) 12
- [9] V. Obendrauf, 40<sup>th</sup> IUPAC Conference, Beijing 2005, Keynote Lecture, Book of Abstracts **2005**
- [10] V. Obendrauf, Trockeneis aus dem Supermarkt, *Chem.Sch.(Salzbg.)* **2005**, 20 (4) 6
- [11] V. Obendrauf, Amorces, Partyknaller, Knallkorken, Pyrotechnisches Spielzeug, *PdN-Ch* **2003**, 52 (5) 22
- [11] V. Obendrauf, Inverse Flammen, „Kann Sauerstoff brennen?“ *Chem.Sch.(Salzbg.)* **2005**, 20 (1) 9
- [12] V. Obendrauf, Chemical Vapour Deposition, Microscale-Experimente mit Silan. *PdN-ChiS* **2005**, 54 (1), 43
- [13] V. Obendrauf, Phosphan – Historische Experimente aktuell *Chem.Sch.(Salzbg.)* **2006**, 21 (2), 11
- [14] V. Obendrauf, Small Scale Hands On zum rotbraunen Gift T+ (Brom). *Chem.Sch.(Salzbg.)* **2006**, 21 (1) 11
- [15] V. Obendrauf, Feuerzeugbenzin im Arbeitstakt. *Chem.Sch.(Salzbg.)* **2000**, 51 (3) 8

This article was reproduced from the Proceedings of the 19th International Conference on Chemical Education, August 12-17, 2006, Seoul, Korea, pp. 10-21, with permission of the Organizer.

Additional note by the author

It is an overview what is possible with my special gas generators. It is also a conclusion about the advantages of microscale chemistry. The crucial point is to use the materials described in particular for the equipment. Otherwise the colleagues could be disappointed. Different syringes have different properties. If dangerous or poisonous gases are involved it is necessary to follow the instructions in detail.